

PRODUCT SPECIFICATIONS

Dayton Stainless Steel 15" x 15" x 5-3/16" Single Bowl Drop-in Bar Sink with 2" Drain Opening (10 Pack). Sink is manufactured from 23 gauge 300 series Stainless Steel with a Satin finish, Center drain placement, and Bottom only pads.

Installation Type:	Drop-in
Material:	300 series Stainless Steel
Finish:	Satin
Gauge:	23
Sound Deadening:	Bottom only pads
Number of Bowls:	1
Sink Dimensions:	15" x 15" x 5-3/16"
Bowl 1 Dimensions:	12" x 10" x 5"
Drain Size:	2" (51mm)
Drain Location:	Center
Minimum Cabinet Size:	18"
Mounting Hardware:	Part # 64090004 included for countertops up to 3/4" (19mm) thick
Template Included:	No
Cutout Template #:	1000001240

Template is available for download at [elkay.com](#). CAD software will be required to open the template.

Cutout Dimensions for Drop-in Installation:
14-3/8" x 14-3/8" (365mm x 365mm) with 1-1/2" (38mm) corner radius

NOTE: MUST BE ORDERED IN MULTIPLES OF 10

Hole Drilling Configurations:
D11515

1-1/2" (38mm) Diameter Faucet Holes on 4" (102mm) Centers

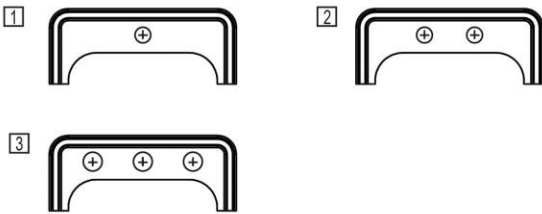

1-1/4" (32mm) Diameter Faucet Holes For 1 and 2 Hole Models
1-1/2" (38mm) Diameter Faucet Holes For 3 Hole Model
Faucet Holes on 4" (102 mm) Centers

PART: _____ QTY: _____
 PROJECT: _____
 CONTACT: _____
 DATE: _____
 NOTES: _____
 APPROVAL: _____



A Century of Tradition and Quality.
For more than 100 years, Elkay has been making innovative products and providing exceptional customer care. We take pride in offering plumbing products that make life easier, inspire change and leave the world a better place.



Product Compliance: ADA & ICC A117.1
ASME A112.19.3/CSA B45.4
Buy American Act

 Sinks are listed by IAPMO® as meeting the applicable requirements of the Uniform Plumbing Code®, International Plumbing Code®, and National Plumbing Code of Canada.

 Complies with ADA & ICC A117.1 accessibility requirements when installed according to the requirements outlined in these standards.

[Clean and Care Manual \(PDF\)](#)
[Installation Instructions \(PDF\) - 100005236](#)
[Warranty \(PDF\)](#)

Similar models are available with: one sink per box

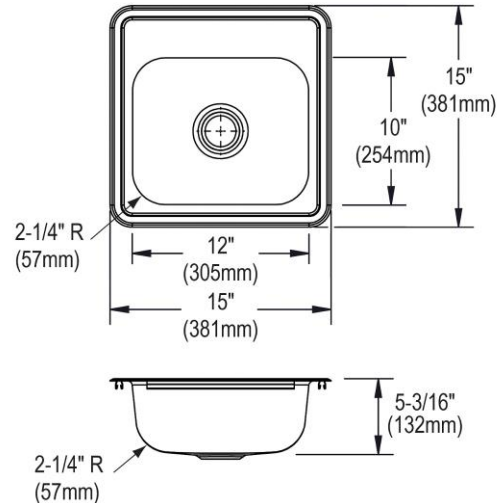

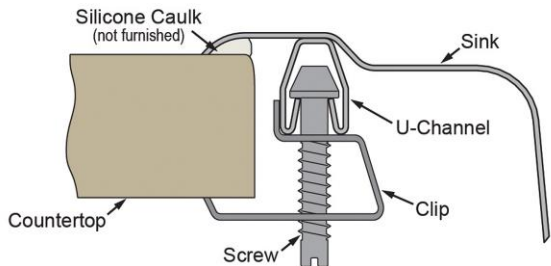

In keeping with our policy of continuing product improvement, Elkay reserves the right to change product specifications without notice. Please visit [elkay.com](#) for the most current version of Elkay product specification sheets. This specification describes an Elkay product with design, quality, and functional benefits to the user. When making a comparison of other producers' offerings, be certain these features are not overlooked.

Installation Profile:



Optional Accessories

<p>CB912</p>	<p>Elkay Hardwood 12-7/8" x 10-1/8" x 1" Cutting Board Spec Sheet (PDF)</p>	
<p>D5018A</p>	<p>Dayton 2" Stainless Steel Drain with Removable Basket Strainer and Rubber Stopper Spec Sheet (PDF)</p>	

In keeping with our policy of continuing product improvement, Elkay reserves the right to change product specifications without notice. Please visit elkay.com for the most current version of Elkay product specification sheets. This specification describes an Elkay product with design, quality, and functional benefits to the user. When making a comparison of other producers' offerings, be certain these features are not overlooked.